

PRAVA U RAVNI

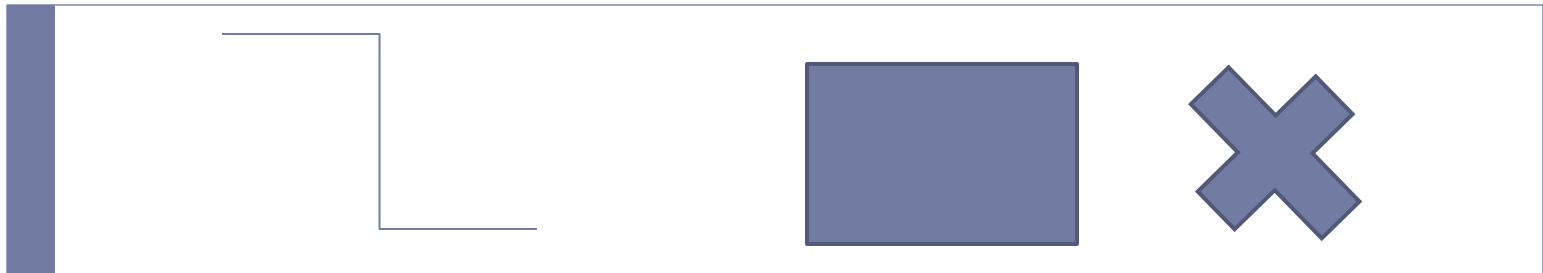
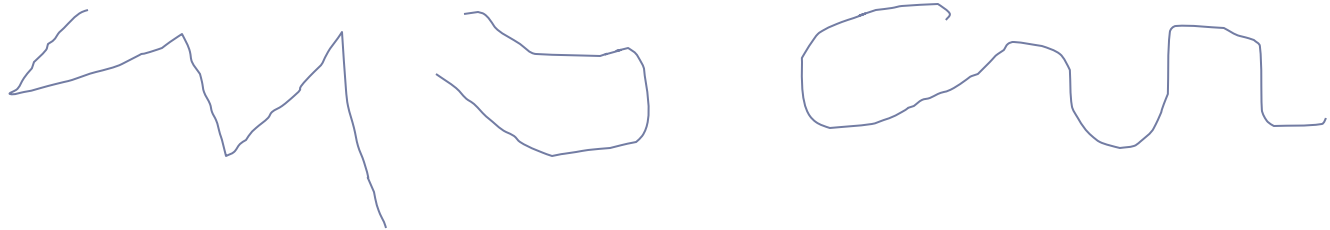

JU OŠ “Dobroševići”

Učiteljica: Bašić Edina

PRAVA U RAVNI

LINIJA:

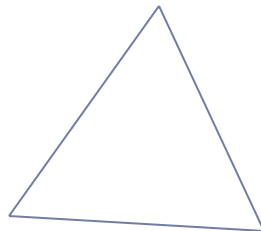
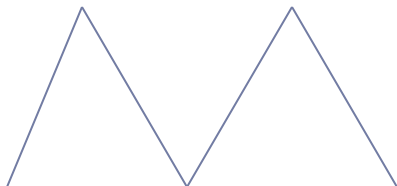
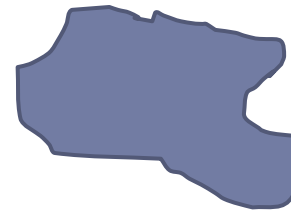
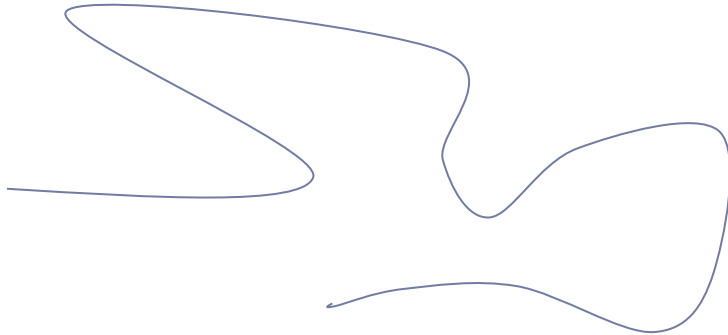
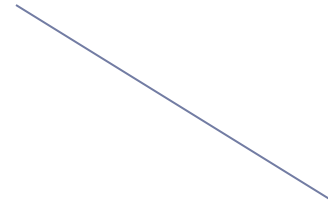
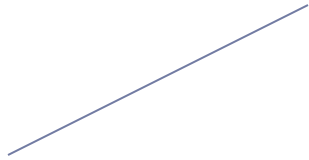

Odnos pravih u ravni

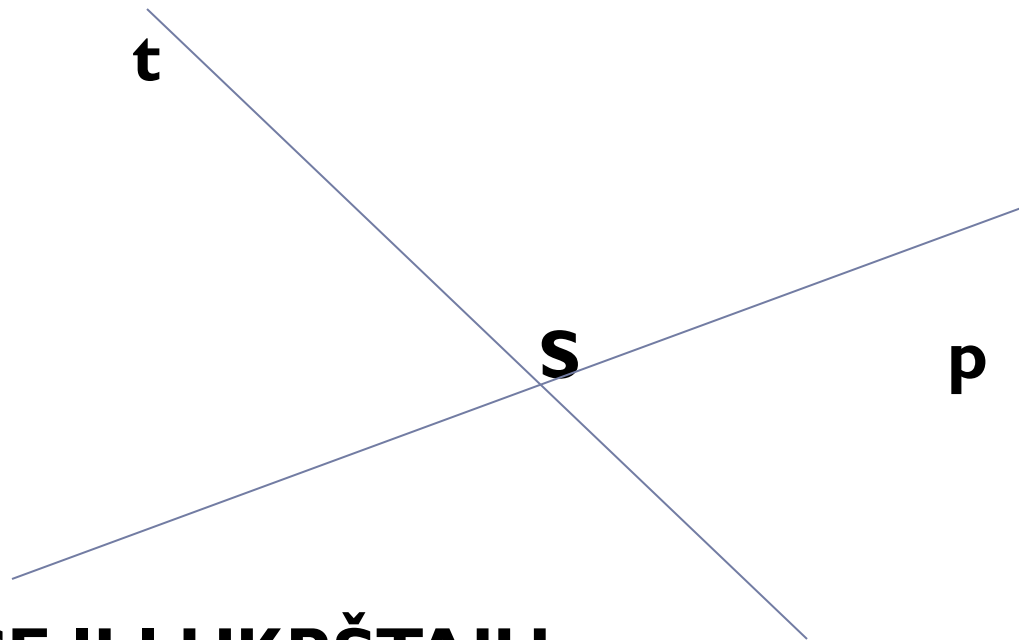

SIJEKU SE ILI UKRŠTAJU

UKRŠTENE PRAVE

TAČKA S JE SJECIŠTE ILI PRESJEČNA TAČKA



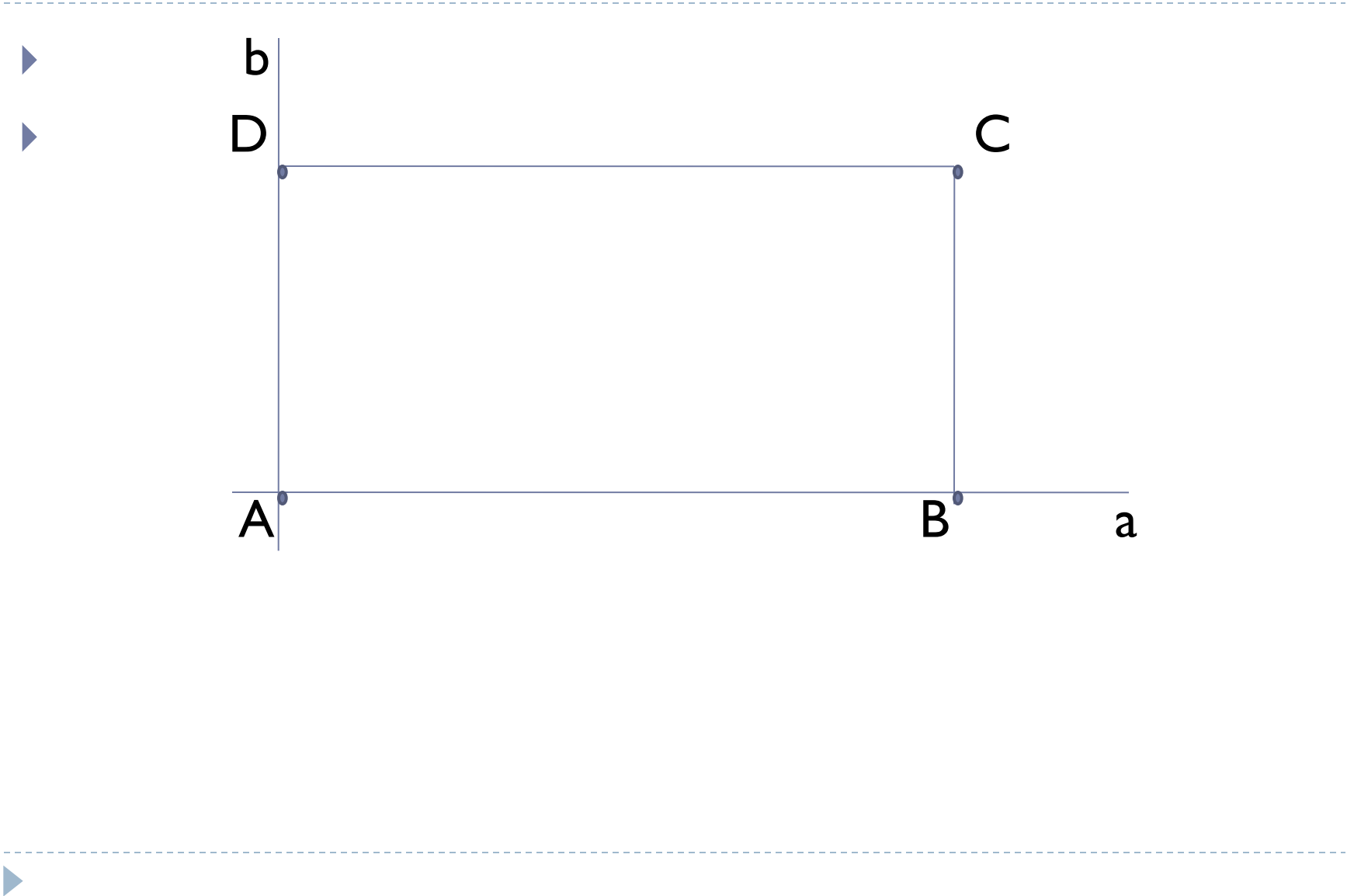

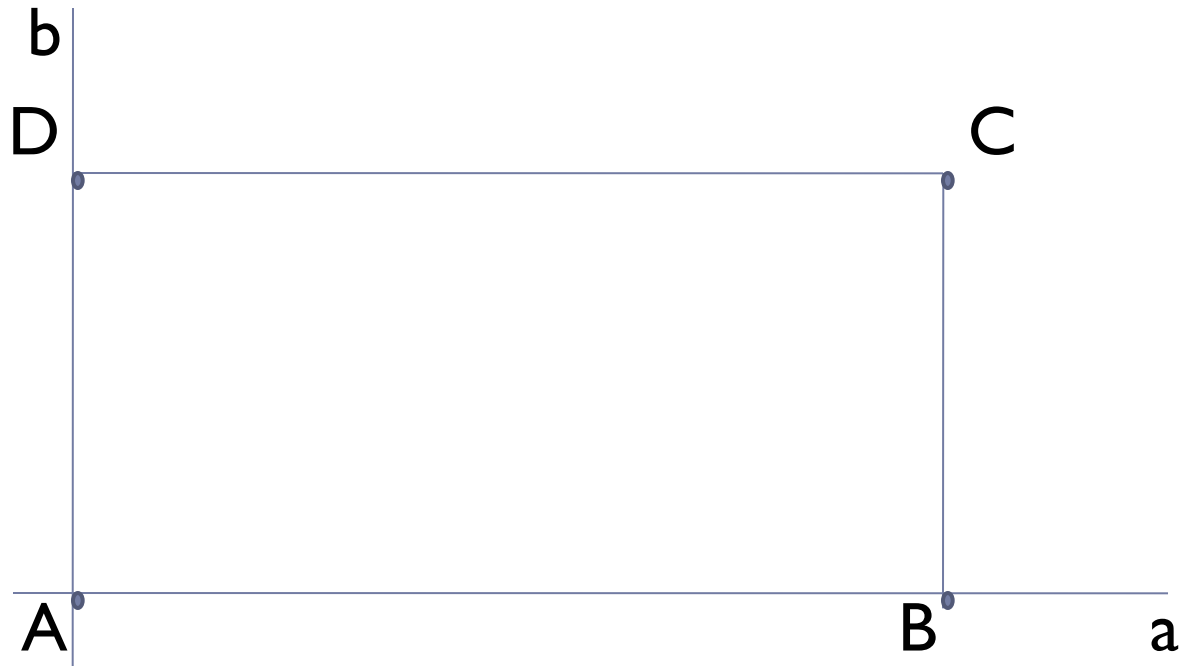

Za prave a i b kažemo da su međusobno okomite.
Zajednička tačka im je tačka A .



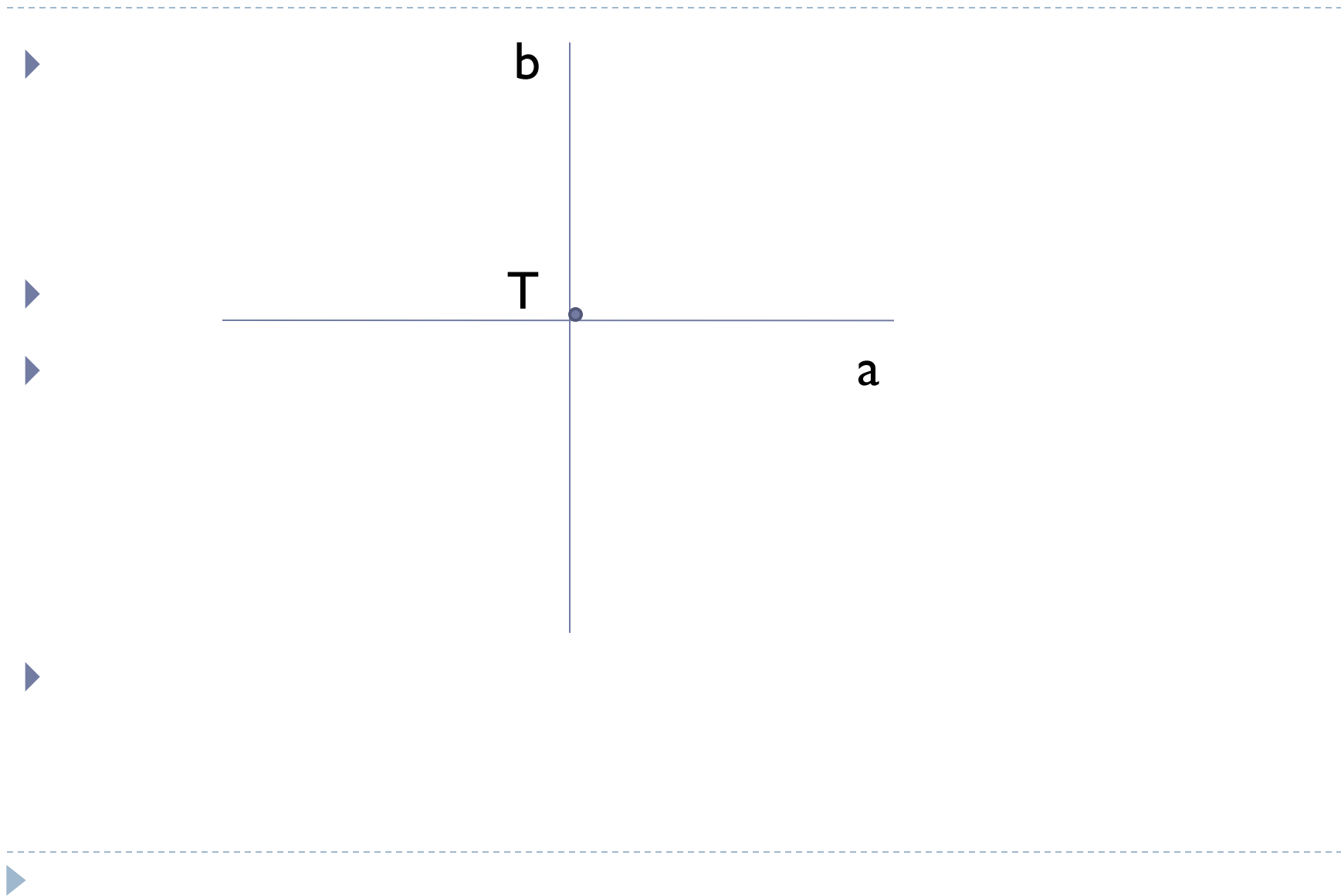



b



T



a

▶ Prava b je okomita na pravu a.

▶ To zapisujemo matematičkim simbolom



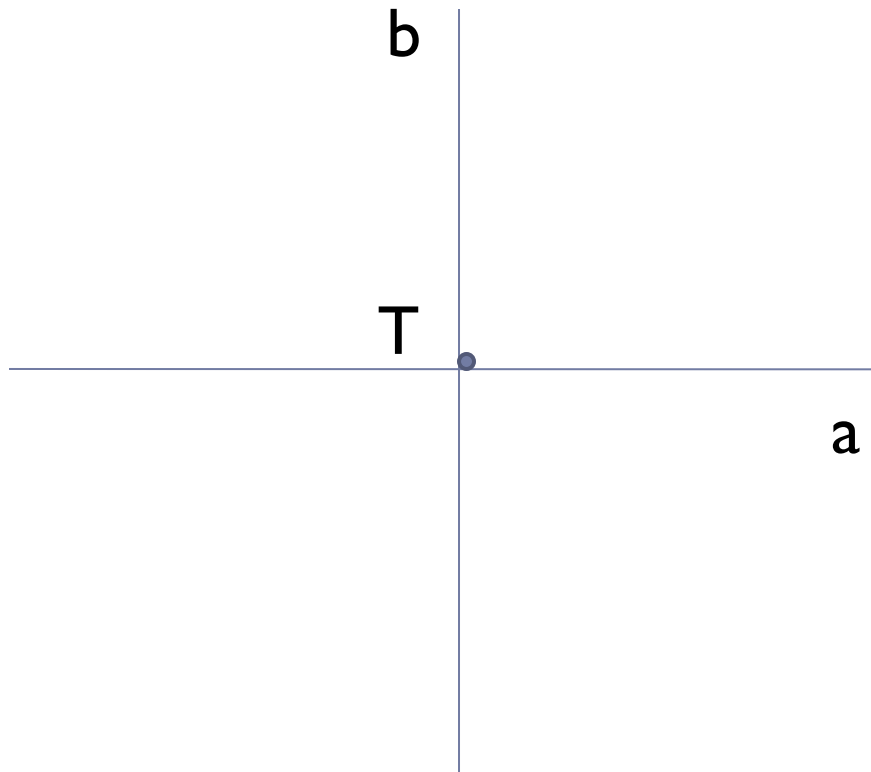

- ▶ Prava b je okomita na pravu a.
- ▶ To zapisujemo matematičkim simbolom \perp koji se čita “je okomit”. Dakle, $b \perp a$, pa je onda i $a \perp b$.



BEZ ALATA NEMA NI ZANATA



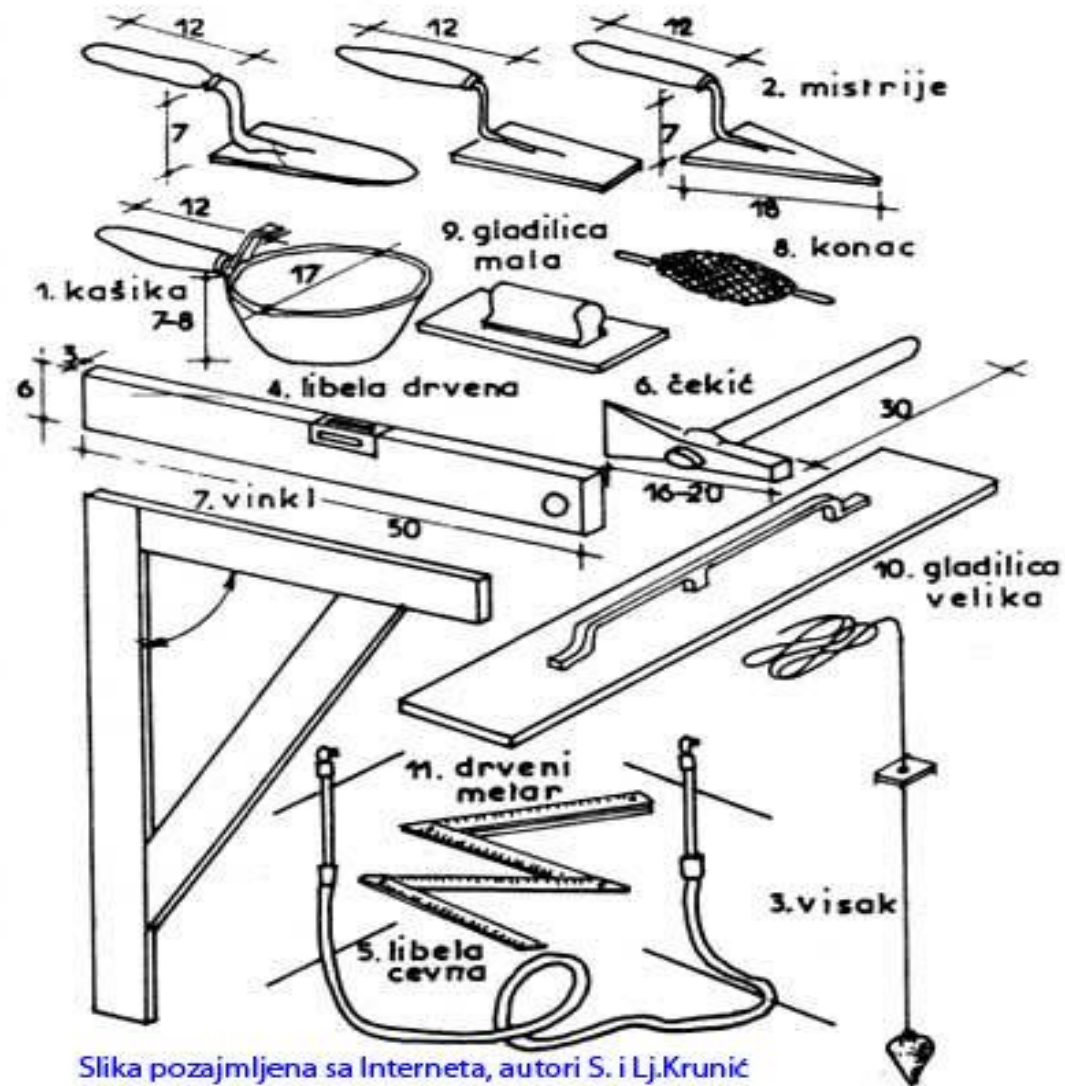

Slika pozajmljena sa Interneta, autori S. i Lj.Krunić



MATEMATIKA JE SVUDA OKO NAS





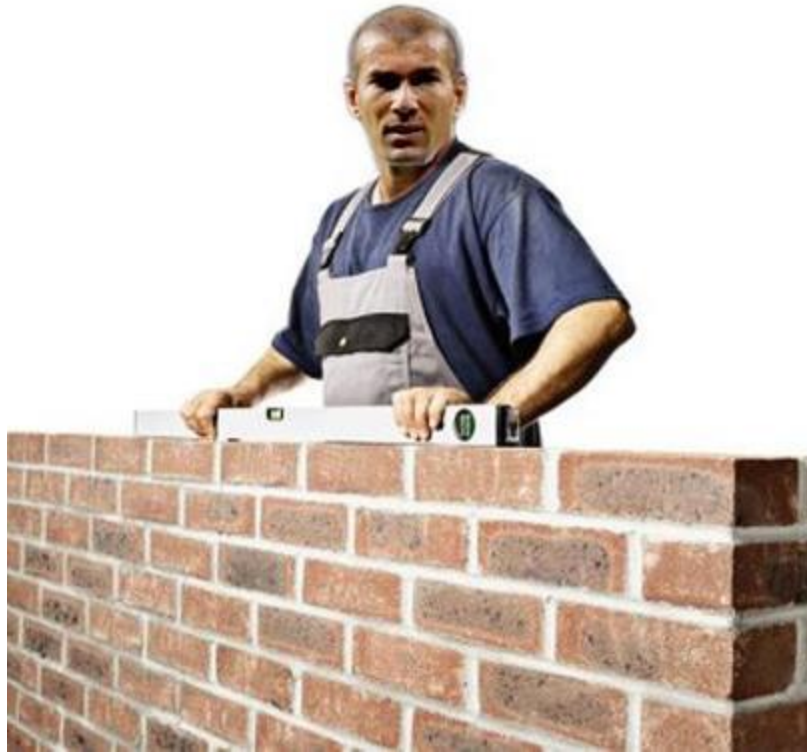

▶ **CRTANJE OKOMITE PRAVE**



Crtanje okomite prave

2. Naučite crtati normalne prave.

Zadana je prava a . Nacrtajmo pravu b koja je normalna na pravu a .

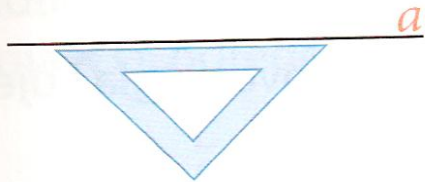

Crtamo ovako:

1. Prislonimo najdužu stranicu trougla uz pravu a .

Crtanje okomite prave

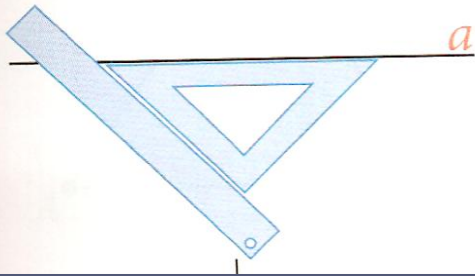

2. Položimo linijar uz drugu stranicu trougla.

Crtanje okomite prave

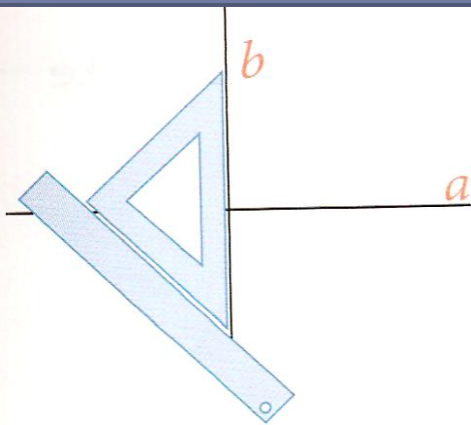

3. Pridržavamo linijar da se ne pomakne, a zatim okrenemo trougao, te mu treću stranicu prislonimo uz linijar. Zatim nacrtamo pravu b uz najdužu stranicu trougla. Nacrtana prava b normalna je na pravu a .

Crtanje okomite(normalne) prave

2. Naučite crtati normalne prave.

Zadana je prava a . Nacrtajmo pravu b koja je normalna na pravu a .

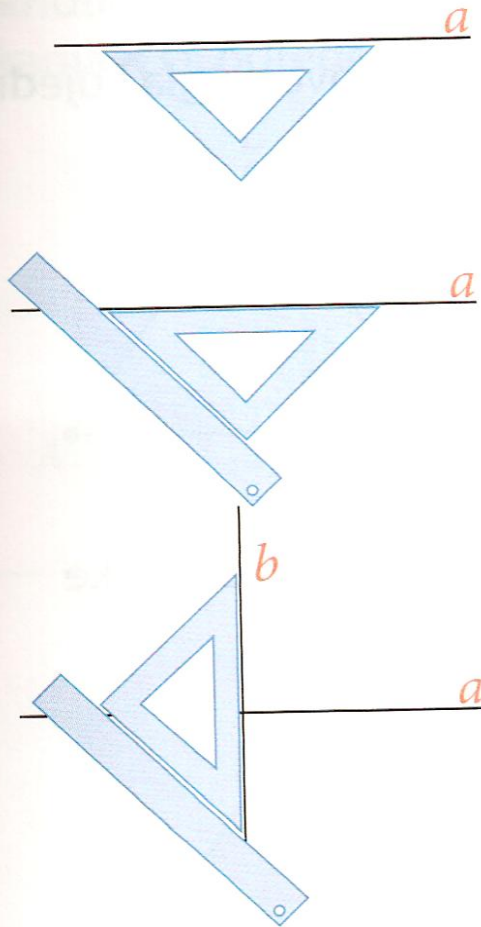

Crtamo ovako:

1. Prislonimo najdužu stranicu trougla uz pravu a .
2. Položimo linijar uz drugu stranicu trougla.
3. Pridržavamo linijar da se ne pomakne, a zatim okrenemo trougao, te mu treću stranicu prislonimo uz linijar. Zatim nacrtamo pravu b uz najdužu stranicu trougla. Nacrtana prava b normalna je na pravu a .

IGRAJMO
SE
OKOMITO



-
- ▶ I
 - ▶ G
 - ▶ R
 - ▶ A
 - ▶ J
 - ▶ M
 - ▶ O
 - ▶
 - ▶ S
 - ▶ E

OKOMITO



IGRAJMO SE OKOMITO

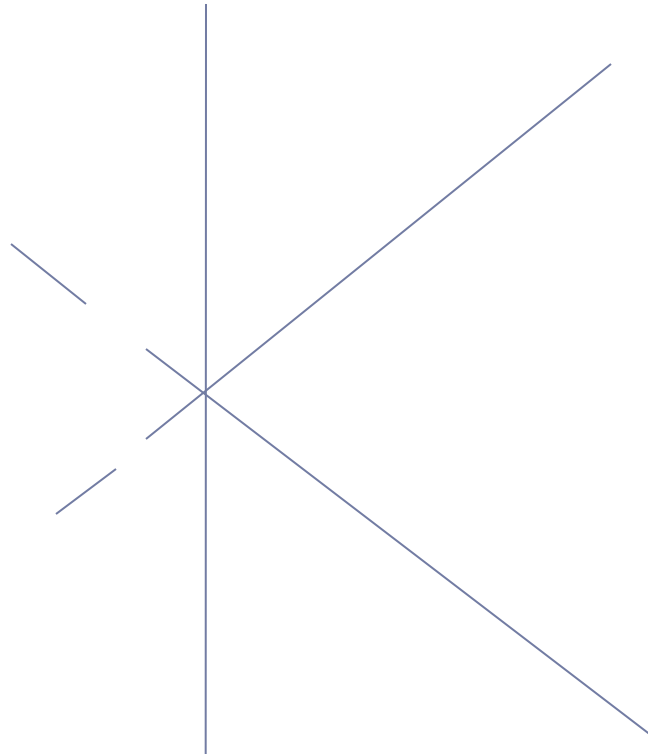

- ▶ Da li su prave ukrštene?
- ▶ Da li su okomite?



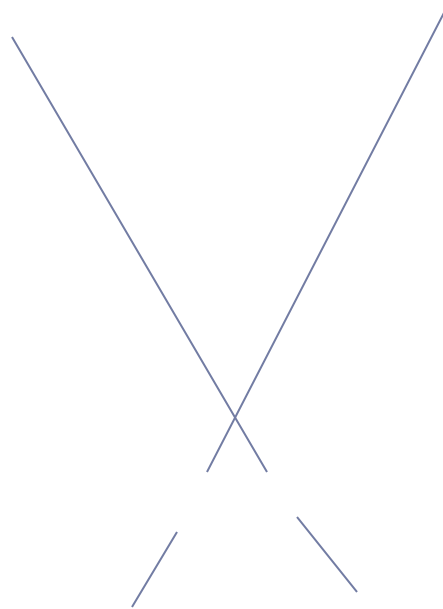

- ▶ Da li su prave ukrštene?
- ▶ Da li su okomite?

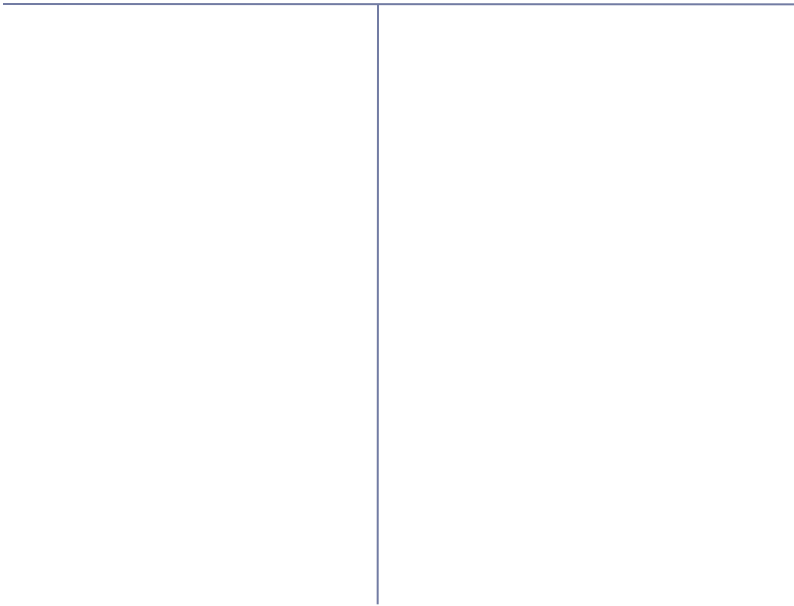

-
- 
- ▶ Da li su prave ukrštene?
 - ▶ Da li su okomite?



-
- ▶ Hvala na pažnji!
 - ▶ Hvala vam okomito na vašoj pažnji
 - ▶ Naučili ste crtati normalnu pravu
 - ▶ I zato budite važni.
-
- ▶ Nemojte da se desi
 - ▶ Kao kod zidara neukih
 - ▶ Umjesto okomito da drže visak
 - ▶ Oni zidaju kosi zid.

